

MASTER

CASIO®

CASIO
SK-1
OPERATION MANUAL
MANUAL DE OPERACION

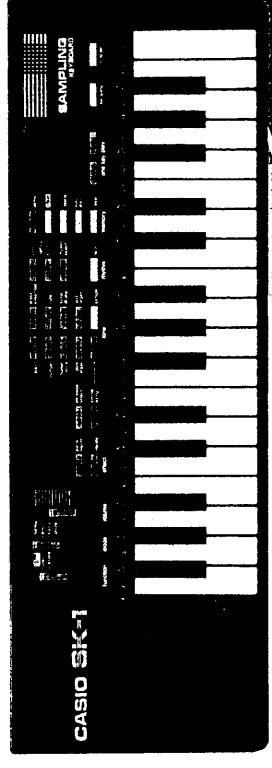

CASIO®

MAIN FEATURES

INTRODUCTION

Congratulations upon your selection of a CASIO SK-1. The SK-1 is a state-of-the-art musical instrument which incorporates the latest electronics technology to make its operation as easy as possible. Exceptional sound quality backed up by a host of sophisticated features and functions makes the SK-1 a joy to play for everyone. In order to enjoy the features and functions of the SK-1 to their fullest, be sure to carefully read this manual and follow the instructions contained herein.

CONTENTS

| | |
|--|-----------|
| MAIN FEATURES | 2 |
| GENERAL GUIDE | 3 |
| ■ BOTTOM PANEL | 5 |
| ■ BACK PANEL | 5 |
| POWER SUPPLY | 6 |
| SAMPLING | 7 |
| ■ SAMPLING PROCEDURE | 7 |
| ■ KEYBOARD PLAY USING SAMPLED SOUND | 8 |
| ■ LOOP SET | 8 |
| TONES & SOUND EFFECTS | 9 |
| AUTO-RHYTHM | 14 |
| ■ TEMPO ADJUSTMENT | 14 |
| ■ FILL-IN | 14 |
| MEMORY FUNCTION | 15 |
| ■ NORMAL MEMORY MODE | 15 |
| ■ 3CH MULTI MEMORY MODE | 19 |
| ■ NOTE LENGTH (CHORD LENGTH) EDITING | 23 |
| TROUBLESHOOTING | 25 |
| CARE OF YOUR UNIT | 26 |
| SPECIFICATIONS | 27 |

• Sampling function

Any audible sound can be stored and incorporated into compositions. Sampling procedures are simple, and stored sounds can even be used for playing chords up to 4-note polyphonic. A loop function makes repeat reproduction of the sound possible.

• A host of sound processing functions

Envelopes can be changed for both sampled sound and preset tones. A synthesizer function allows creation of original sounds.

• Eight realistic preset tones

Five realistic tones are produced on the PCM sound source, while harmonic synthesis produces another three tones. Tone selection is performed with the touch of a button.

• Memory function

Compositions can be stored as they are played on the keyboard in up to 4-note polyphonic (real-time memory). Up to two melodies and one chord progression can be stored separately (3-channel multi memory), while Auto Playback and One Key Play even allows beginners to play with ease.

- ① **Built-in speaker**
- ② **Function selector power off** Keyboard power OFF.
play For normal keyboard play, One Key Play, or Memory play.
- ③ **Power indicator**
Lights when unit power is switched ON.
- ④ **Mode selector normal** 4-note polyphonic
solo 1 Monophonic (with multi track memory)
solo 2 Monophonic (with multi track memory)
chord Accompaniment (with multi track memory)
- ⑤ **Volume control**
Control volume level.
- ⑥ **Portamento ON/OFF button**
Switches portamento effect ON and OFF.
- ⑦ **Vibrato ON/OFF button**
Switches vibrato effect ON and OFF.
- ⑧ **Synthesizing button**
Used when creating sounds using harmonic synthesis.
- ⑨ **Envelope select button**
Applies one of 13 available envelopes to each tone.
- ⑩ **Tone selectors**
Used to select the desired tone.
- ⑪ **Tempo control**
Controls rhythm tempo. Each press of ▲ button increases tempos, while each press of ▼ decreases tempo.
- ⑫ **Rhythm button**
Press to allow selection of one of the 11 auto-rhythms using rhythm selector buttons. The rhythm will start the moment the rhythm selector button is pressed.
- ⑬ **Fill-in button**
Inserts a fill-in (rhythm grace) into the music during play.
- ⑭ **Demo (demonstration) button**
Plays a preset demonstration piece (Toy Symphony).
- ⑮ **Clear button**
Clears the previous memory contents. Set the functions selector to "record" and then press clear to prepare memory for new input.
- ⑯ **Delete button**
Used to clear errors from a melody in memory.
- ⑰ **Auto play button**
Plays back melody stored in memory.
- ⑱ **Reset button**
Press after storing a melody in memory.
- ⑲ **One Key Play buttons**
Play one note of melody stored in memory with each press.
- ⑳ **Sampling button**
Begins sampling (recording).
- ㉑ **Built-in microphone**
Used to pick up sampled sound.
- ㉒ **Loop set button**
Press to make sampled sound continuous.
- ㉓ **Chord selector keys**
Produce the indicated chord when the mode selector is set to chord.
- ㉔ **Envelope selector keys**
Used to select the desired envelope after the envelope select button is pressed.
- ㉕ **Rhythm selector keys**
Used to select the desired rhythm after the rhythm select button is pressed.
- ㉖ **Foot selector keys**
Used to select the desired harmonic synthesis after the synthesizing button is pressed.

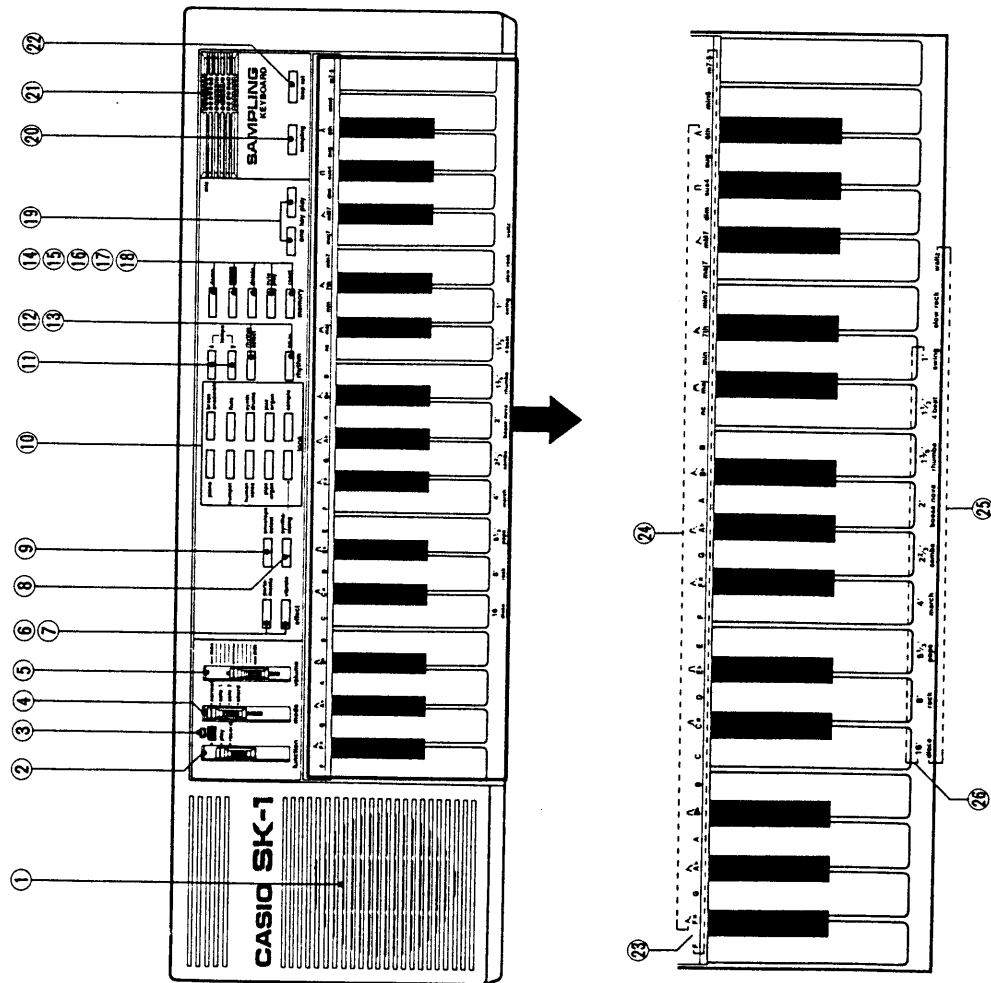

■ BOTTOM PANEL

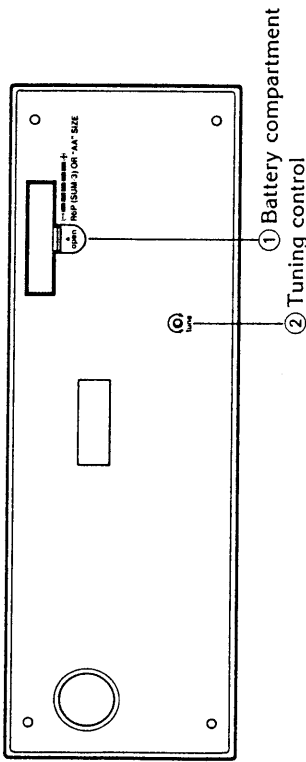

① Battery compartment

Load five AA-size batteries for power.

② Tuning control

Used to adjust the pitch of the entire keyboard within the range of ± 50 cents for easy tuning with other musical instruments.

NOTE:

Use an insulated screwdriver (resin handle) for more precise tuning.

■ BACK PANEL

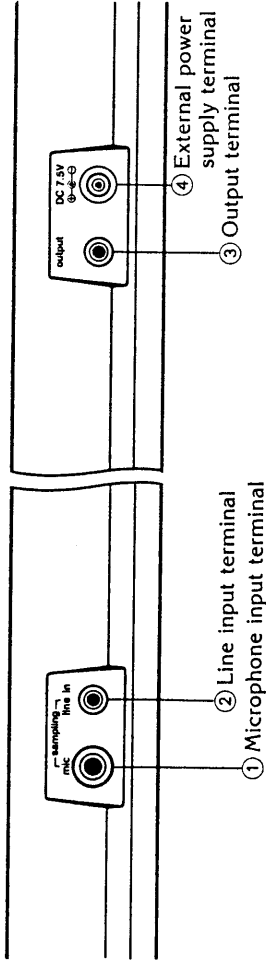

① Microphone input terminal

For connection of an external microphone to use for sampling sounds.

② Line input terminal

For connection of audio equipment for sampling.

③ Output terminal

For connection of optional headphones, audio amplifier or keyboard amplifier. Connecting headphones automatically cuts speaker output.

NOTE:

Only connect external devices when the power of the SK-1 is switched OFF.

④ External power supply terminal

For connection of optional AC adaptor (AD-1) or car adaptor (CA-1).

POWER SUPPLY

This unit operates on both AC and DC power.

DC Power

• Dry batteries

This unit can be powered by five AA-size (SUM-3) manganese dry batteries. Weakened batteries will result in lower volume or poor tonal quality. The power indicator lamp will gradually lose its brightness when battery power weakens. At this time, change batteries or shift to one of the alternate power sources mentioned below.

Battery replacement:

- ① Slide open the battery compartment cover on the bottom of the unit and take out used batteries.
- ② Load new batteries taking care that polarity is correct.
- * It is advisable to replace all five batteries at the same time for longer battery life.
- * Refer to the specifications for standard battery life.

• Car battery adaptor

With the car battery adaptor (CA-1, optional), DC power is supplied from a car battery through the cigarette lighter socket.

AC Power

An AC adaptor (AD-1, optional) is required to connect to an AC outlet.

Use only an adaptor with the same voltage rating (100, 117, 220 or 240V) as the power supply in your area to prevent component damage. Plug the AC adaptor into the AC outlet and the cord into the unit. This will automatically cut off the battery power supply.

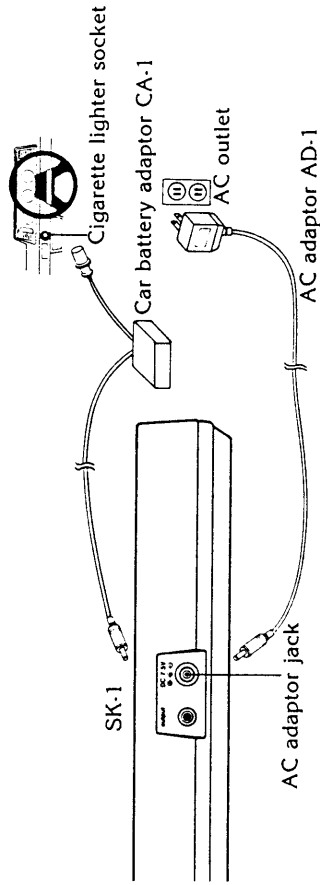

• Auto power off

Power is automatically cut off approximately 7 minutes after the last operation of the unit. Power supply can be restored by switching power OFF and then ON again.

CAUTION

- * Use only genuine CASIO adaptors.
- * Remove the batteries from the battery compartment when the unit is not used for extended periods. (Battery leakage can damage electrical parts.)
- * The adaptor may become warm when left connected to an outlet. This is normal, but the adaptor should be disconnected when not in use.
- * THE FOLLOWING CONDITIONS CAN CAUSE BATTERIES TO BURST:
 1. Use of adaptors other than genuine CASIO adaptors.
 2. Loading batteries with polarities reversed.

Virtually any audible sound can be recorded into the memory of the SK-1 and then incorporated into musical performances.

The features of the SK-1 sampling function are as follows:

- A built-in microphone simplifies sampling procedures. Sampling can also be performed using an external microphone or by connection of an external device.
- A loop function causes sampled sounds to repeat when the keyboard is pressed.
- The envelope of the sampled sound can be changed for creations of a new sound.

■ SAMPLING PROCEDURE >

A. Using the built-in microphone

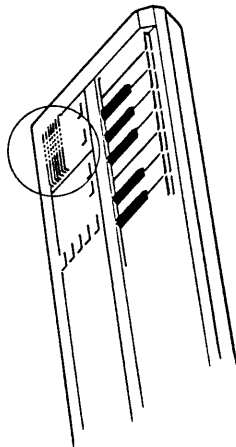

- ① Set the function selector to "play".
 - ② Press the sampling button.
 - ③ Produce the sound to be sampled near the built-in microphone. Sampling begins automatically when sound is detected (auto trigger).
 - ④ Sampling continues for 1.4 seconds, and 2 to 3 seconds later another sharp metallic sound will be heard to indicate that sampling is complete.
 - ⑤ Press the reset button to complete sampling operations.
- *Repeat steps from step ② to replace the sampled sound with a newly sampled sound.

B. External microphone/line input

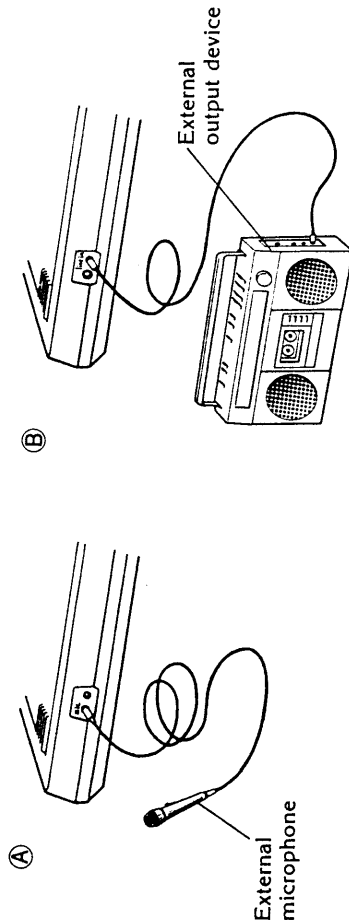

- ① Connect an external microphone to the MIC input terminal or connect the external device to the line input terminal on the back of the SK-1.
 - ② Set the function selector to "play".
 - ③ Press the sampling button.
 - ④ Sampling begins automatically when sound is detected.
 - ⑤ Sampling continues for 1.4 seconds, and 2 to 3 seconds later another sharp metallic sound will be heard to indicate that sampling is complete.
 - ⑥ Press the reset button to complete sampling operations.
- *Repeat steps from step ② to replace the sampled sound with a newly sampled sound.

■ KEYBOARD PLAY USING SAMPLED SOUND

- ① Set the function selector to "play", and the mode selector to "normal".
- ② Press the tone selector marked "sample".
- ③ The sampled sound is produced when the keyboard keys are pressed.

■ LOOP SET

Pressing the loop set button causes the sampled sound to be produced as long as a keyboard key is held down. The loop function is switched ON and OFF with each press of the loop set button. A signal sounds when this key is pressed to confirm operation.

*The waveform of the sampled sound can be set using the envelope select button (see page 9).

NOTES:

- The A key at the center of the keyboard corresponds to the pitch of the sampled sound.
- The sampling period is approximately 1.4 seconds. After sampling, the sound is processed internally, and then a sharp metallic sound is produced to signal processing is complete.
- Sampling from a tape recorder may cause some changes in sound quality.
- The built-in microphone cannot be used for sampling when a line is connected to the external microphone or line in terminal. The priority for connections is: line in, external microphone, built-in microphone.
- Pressing the sampling key puts the unit into the sampling stand by mode. In this mode, power is not switched off when the function selector is set to "power off". Power is switched off when the reset key is pressed to complete the sampling operation.

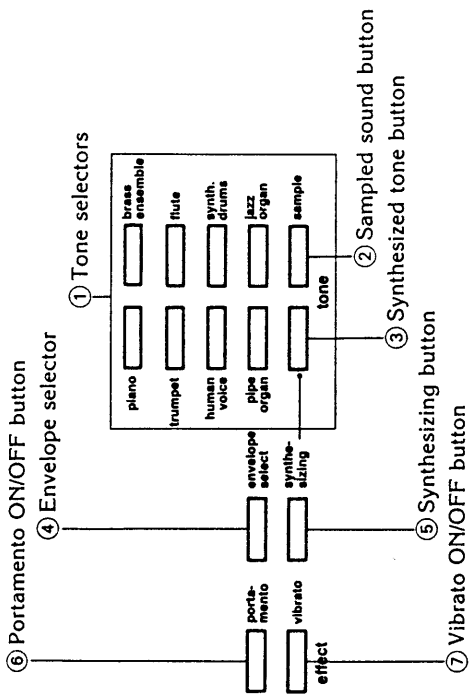

① Tone selectors
Used to select a tone.

② Sampled sound button
Recalls the sampled sound. A sharp metallic sound is produced when no sampled sound is present in memory, and the original preset tone is maintained.

③ Synthesized tone button
Recalls harmonic synthesized sound created using the synthesizing button ⑤.

④ Envelope selector
New sounds can be created by changing the envelopes of preset tones, sampled sounds, and harmonic synthesized sounds.

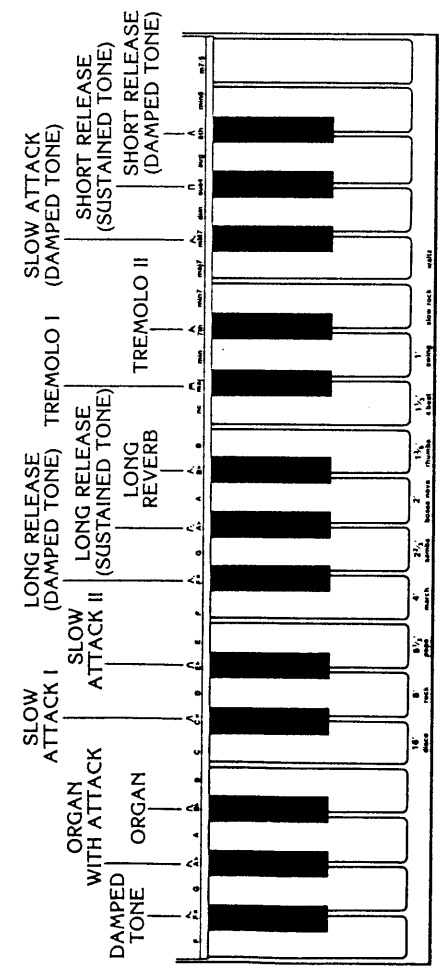

- (1) Set the function selector to "play".
 - (2) Select a tone.
 - (3) Press the envelope select button and press the selector key that corresponds to the desired envelope.
 - (4) Press the reset button and then try pressing a key on the keyboard. The sound produced should correspond to the envelope selected.
- * Repeat from step ② to change envelope to another selection.

(NOTE)
Sounds produced by altering the envelopes of preset tones and the sampled sound are erased when any Tone selector button is pressed.

(Reference) More about envelopes

Selecting the FLUTE preset tone and then setting the DAMPED TONE envelope on the far left makes the flute tone take on a piano-like quality. This is caused by a change in resonance (change in volume pattern) as shown in the following illustration.

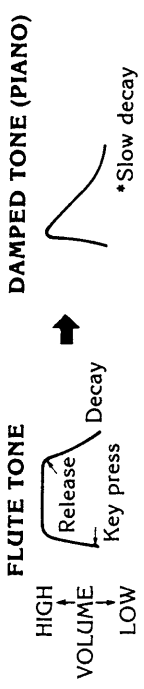

Such resonance or the changes in volume from the point at which the tone is sounded until it diminishes is the tone's "envelope". A variety of envelope forms are applied depending upon the tone, and a tone's envelope is an essential element in determining the distinctive sound of the tone. A total of 13 different envelopes are available on the SK-1, thus making it possible to produce various effects using a single tone.

- ① ... Piano/guitar damped tone, slow decay
- ② ... Organ with attack, attack applied at key press
- ③ ... Organ, fixed volume sustained while keys pressed
- ④ ... Slow attack I, }
⑤ ... Slow attack II, }
slow increase of volume at beginning as with violin or cello
- ⑥ ... Long release (damped tone), slower decay than ①
- ⑦ ... Long release (damped tone), same sustain as ③, slow decay when keys released
- ⑧ ... Long reverb, some sustain after decay begins
- ⑨ ... Tremolo I, slight vibrato
- ⑩ ... Tremolo II, slower vibrato than ⑨
- ⑪ ... Slow attack (damped tone), slow deterioration
- ⑫ ... Short release (sustained tone), free of reverberation
- ⑬ ... Short release (damped tone), almost no reverberation for effect like striking wood

⑥ Synthesizing button

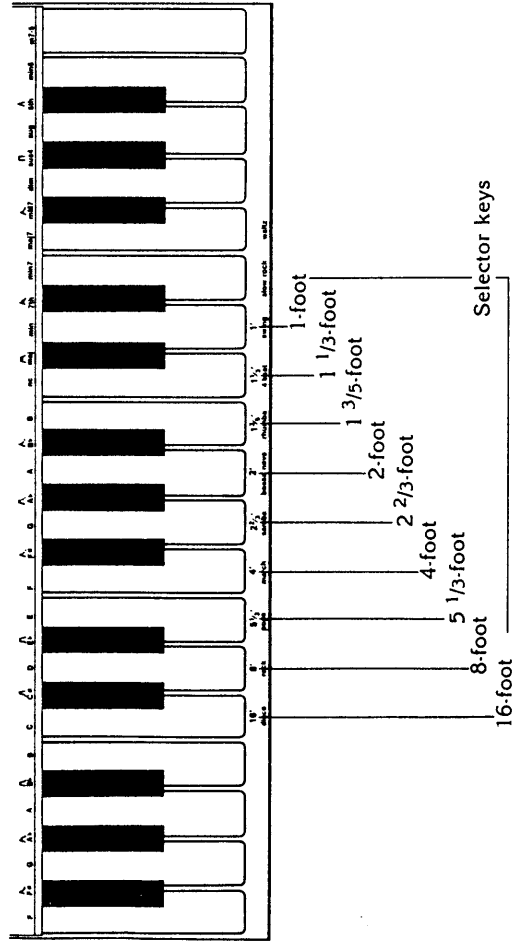

Sounds can be freely processed by applying harmonics to the basic tone.

- (1) Set the function selector to "play".
- (2) Press the synthesizer key.
- A basic tone will sound from the speaker.
- (3) Select and press the selector key that corresponds to the desired harmonic.
- Each press of a selector key changes to the selected harmonic.
- (4) Press the reset key when the desired sound is achieved.
- (5) The tone created using the above procedure can be selected by pressing the synthesizing tone button.

NOTE:

Tones created using harmonic synthesis are retained in memory until the power of the unit is switched off or until the synthesizing key is pressed again.

(Example) Clarinet sound

- (1) Set function selector to "play".
- (2) Set mode selector to "normal".
- (3) Press synthesizing key. Basic (6') sound should be produced.
- (4) Press 16' white key 4 times, 8' white key once, and 5 1/3' white key 3 times.
- (5) After pressing envelope select key, press envelope black key.

Now try pressing a few keys on the keyboard, and you will hear a sound that resembles a clarinet. The table below shows a number of harmonic component examples. Experimenting with other combinations will provide you with the ability to form a wide variety to sounds.

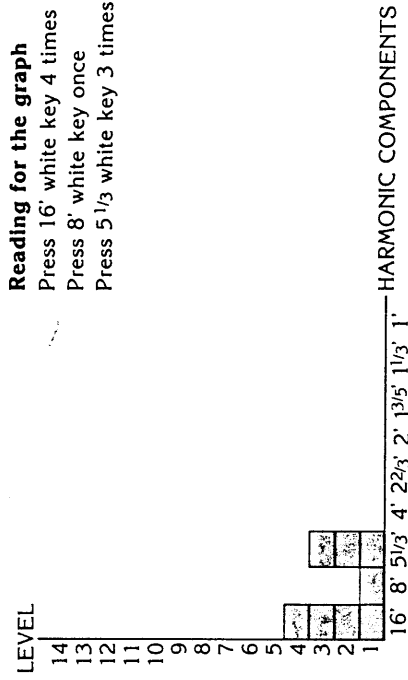

HARMONIC COMPONENT EXAMPLES

| TONE NAME | 16' | 8' | 5 1/3' | 4' | 2 2/3' | 2' | 1 3/5' | 1 1/3' | 1' | ENVELOPE PATTERN |
|----------------|-----|----|--------|----|--------|----|--------|--------|----|------------------|
| VIBRAPHONE 1 | | | | | | | | 1 | 1 | |
| VIBRAPHONE 2 | | | | | 1 | | 2 | 3 | | |
| ORGAN | 5 | 3 | | | | | | | | |
| HARPSICHORD | | 1 | 1 | 1 | | 2 | 2 | 2 | 2 | |
| VIOLIN | 1 | 1 | | 1 | 1 | 2 | 2 | 2 | 2 | |
| OBOE | | 3 | 5 | | | | | | | |
| CLARINET | 4 | 1 | 3 | | | | | | | |
| ELECTRIC PIANO | 10 | 4 | | | | | | | 1 | |
| TOY PIANO | | | | | | | | 1 | 6 | |

Numbers indicate number of times white harmonic keys are pressed. A maximum of 14 times can be applied per each key.

⑥ Portamento ON/OFF button

Portamento causes notes to slide from one to another as they are pressed on the keyboard.

- (1) Set the function selector to "play".
- (2) Use the tone selectors to set the desired tone. (This effect is best applied to the piano or pipe organ tones.)
- (3) Press the portamento key.
- (4) Press and hold down a key on the keyboard. While still holding down the original key, press another key on the keyboard and the note will slide from the first note to the second.

*Press the portamento key again to cancel the portamento effect. Repeating step ④ will now result in notes being played independently of each other.

⑦ Vibrato ON/OFF button

The vibrato effect applies a slight vibration to the sound. Each press of the vibrato key switches this effect ON and OFF.

AUTO-RHYTHM

- ① Set the function selector to "play".

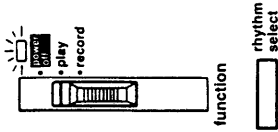

- ② Press the rhythm select button.

- ③ Choose one of the 11 available rhythms by pressing a rhythm selector key.

- The selected rhythm starts to play when the keyboard keys are pressed.
- Press the reset button to stop the rhythm play.
- Steps ② and ③ can be repeated during rhythm play to change to another rhythm.



■ TEMPO ADJUSTMENT

The tempo controls are used to adjust the speed at which the rhythm is played. Each press of the ▲ key increases tempo, while ▼ decreases tempo.



■ FILL-IN

A fill-in rhythm pattern is inserted each time the fill-in button is pressed during rhythm play.

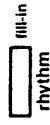

SK-1 features a normal memory and a 3ch multi memory mode. After a melody is stored, it can be played back by Auto-play or One Key Play.
 *Normal memory and multi memory can not be used simultaneously.

■ NORMAL MEMORY MODE

Enter notes in proper order by playing them at any pace on the keyboard. Then replay the notes using One Key Play, setting the length of each note. Normal memory mode can hold a melody of up to 400 notes.

1. Storing a melody

< Entering notes >

- Set the function selector to 'record'.
- Set the mode selector to 'normal'.
- Press the 'clear' button (this empties the memory).
- Play the notes on the keyboard at any speed.

Try this song:

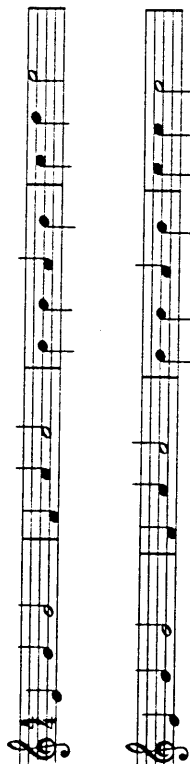

If you make a mistake, press the 'delete' button and then enter the correct note.

< Length of each note >

- Press the 'reset' button.
- Choose the most appropriate rhythm by first pressing the 'rhythm select' button and then a rhythm selector key. 'Rock' will match the above melody.

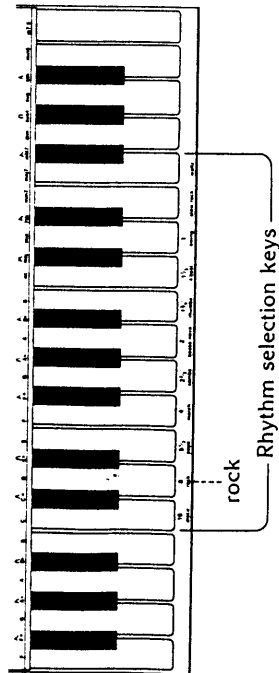

- Set a suitable tempo by using the tempo controls.
- Play the melody using the One Key Play buttons.

*Each press of the One Key Play buttons will play a stored note.

*After the last note of the melody is played, press a One Key Play button once more in time with the rhythm (this rounds off the performance).

*4-note polyphonic input is possible in the NORMAL MEMORY MODE. A monophonic selection is used in the example to make the explanation easier to understand.

Easy memory operation, even for beginners

- Set function mode to "record".

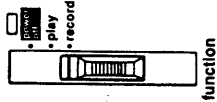

- After pressing rhythm select key, press the desired rhythm white key and start rhythm.



- Press tempo key and adjust rhythm to appropriate speed.



- Press keyboard in time with rhythm for memory input.

- Press reset key when memory input is complete.

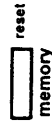

NOTE

Be sure to press the clear key to delete previous memory contents when using multi-memory after manual memory.

NOTES

- Memory capacity:
Up to 400 notes can be stored in the memory of the SK-1.
* You can enter two or more melodies as long as their total notes are less than 400. If you want to enter another melody, set the mode selector to 'record' and play the present melody to the end with One Key Play buttons, then enter the next.
- Memory contents are cleared when the power is turned off.
- After polyphonic recording to memory, the note may not play back when the One Key Play buttons are used.

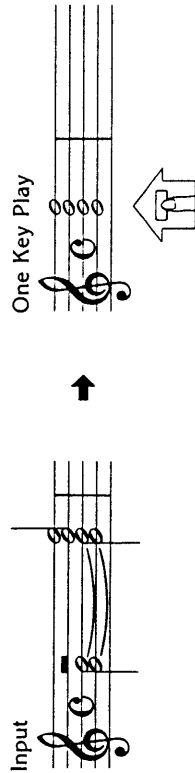
(Example)

Notes are produced in the timing that the One Key Play buttons are pressed. Each press of a One Key Play button produces the next independently input note.

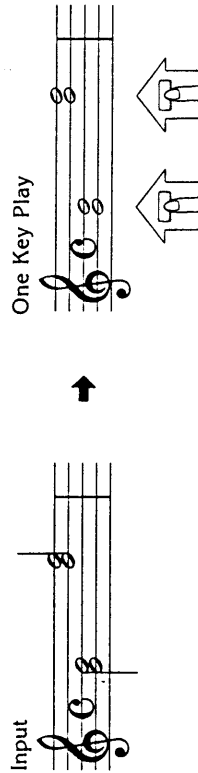
**2. Playback with Auto play or One Key Play**

Now playback the stored melody using Auto play or One Key Play.

< Auto play >

- Set the function selector to 'play'.
 - Set the mode selector to 'normal'.
 - Start the rhythm. First press the 'rhythm select' button and then a rhythm selector key.
 - Press the Auto play button in time with the rhythm.
- * Press the reset button to stop the Auto play.

< One Key Play >

- Set the function selector to 'play'.
- Set the mode selector to 'normal'.
- Start the rhythm.
- Tap the One Key Play buttons.

* It does not matter which of the two One Key Play buttons is pressed, or whether they are pressed in turn.

NOTES

- Omit c. in the above procedure for Auto play or One Key Play without auto rhythm.
- One Key Play can be repeated by continuing to play the One Key Play buttons after the tune ends.
- The memory contains the "Toy Symphony" after the demo button is used to play the demonstration tune.

3. Corrections**< Immediate >**

Press the Delete button and play the correct note.  delete

< After storage >

Set the function selector to 'record' and use the One Key Play buttons to take the melody up to the note to be corrected. Make corrections as follows.

- Deletion
Press the Delete button and the note will be deleted.
- Replace
Play the correct note after pressing the Delete button.
- Addition
Use the One Key Play buttons. To move to the note immediately preceding the point where a new note is to be inserted. Then play the note.

3CH MULTI MEMORY MODE

Chords and 2 melodies can be independently stored in memory for playback using Auto play or One Key Play.

1. Storing chords

< **Entering chords** >

- a. Set the function selector to 'record'.
- b. Set the mode selector to 'chord'.
- c. Press the 'clear' button (this empties the memory).
- d. Choose a rhythm by first pressing the 'rhythm select' button and then a rhythm selector key.
- e. Play chords on the keyboard using the chord selection keys.
- f. Press the 'reset' button.

Try this song as a starter:

Main melody → Solo 1 Memory

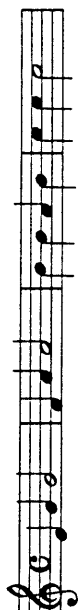

Sub melody → Solo 2 Memory



Chord → Chord Memory



CHORD SELECTION

< **Casio Chord System** >
 Pressing one of the root keys produces a major chord corresponding to that note. Simultaneously pressing any key to the right (two keys at the same time) results in a minor chord. Similarly, pressing one more key to the right (three keys in all) produces a seventh chord, and pressing the fourth key to the right (four keys in all) creates a minor seventh chord.

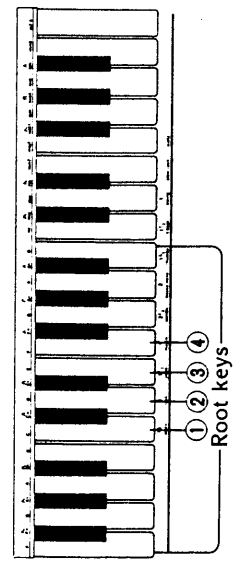

(Example)

- C (C major chord) — Press ①.
- Cm (C minor chord) — Press ①, ② together.
- C7 (C seventh chord) — Press ①, ②, ③ together.
- Cm7 (C minor seventh chord) — Press ①, ②, ③, ④ together.

*Not only ②, ③ and ④, but any black or white keys can be used as long as they are to the right of ①.

< **Other chord variations** >

Chord selection keys are divided into two major parts — Root keys and Variation keys. Various chords become easy to play by combining these two types of keys.

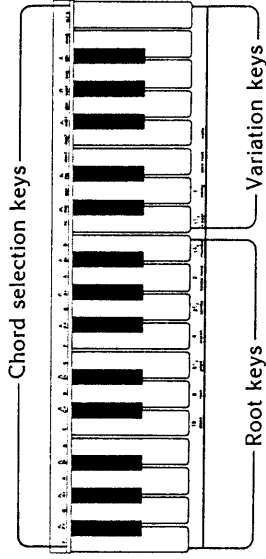

(Example)

- Am (A minor chord) — Simultaneously, press A (Root key) and min (Variation key).
- F# maj7 (F sharp major 7th) — Simultaneously, press F# (Root key) and maj7 (Variation key).

NOTES

1. Memory capacity: Up to 99 chords can be stored in the chord memory.
2. Memory contents are cleared when power is switched off.

2. Storing a melody in Solo 2.

Entering notes 1 — < While listening to auto play >

- Set the function selector to 'record'.
- Set the mode selector to 'solo 2'.
- Press the 'clear' button (this empties memory).
- Press the 'auto play' button to produce the stored chords.
- Play notes on the keyboard following the chords.
- Press the 'reset' button.

Main melody  → Solo 1

Sub melody  → Solo 2

Chord  → Chord

Entering notes 2 — < While listening to rhythm >

- Set the function selector to 'record'.
- Set the mode selector to 'solo 2'.
- Press the 'clear' button (this empties memory).
- Choose a rhythm using the 'rhythm select' button and rhythm selector key.
- Play notes on the keyboard following the rhythm.
- Press the 'reset' button.

Main melody  → Solo 1

Sub melody  → Solo 2

Chord  → Chord

NOTES

- Memory capacity; Up to 198 notes can be stored in solo 2 memory.
- Memory contents are cleared when the power is turned off.

3. Storing a melody in Solo 1

Entering notes 1 — < While listening to stored chords and melody >

- Set the function selector to 'record'.
- Set the mode selector to 'solo 1'.
- Press the 'clear' button (this empties memory).
- Press the 'auto play' button to produce the stored chords and melody.
- Play notes on the keyboard in time with the chords and melody.
- Press the 'reset' button.

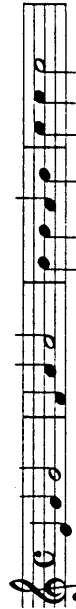
Main melody  → Solo 1

Sub melody  → Solo 2

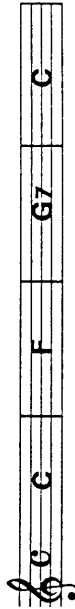
Chord  → Chord

Entering notes 2 — < While listening to rhythm >

- Set the function selector to 'record'.
- Set the mode selector to 'solo 1'.
- Press the 'clear' button (this empties memory).
- Choose a rhythm using the 'rhythm select' button and a rhythm selector key.
- Play notes on the keyboard in time with the rhythm.
- Press the 'reset' button.

Main melody  → Solo 1

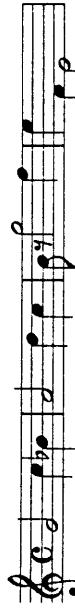
Sub melody  → Solo 2

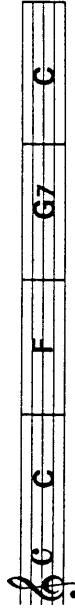
Chords  → Chords

NOTES

- Memory capacity; Up to 198 notes can be stored in the solo 1 memory.
- Memory contents are cleared when the power is turned off.

4. Playback using Auto play or One Key Play

Now playback the stored melody using Auto play or One Key Play.

<Auto play>

- Set the function selector to 'play'.
 - Set the mode selector to 'solo 1', 'solo 2' or 'chord'.
 - Press the auto play button.
- * Press the reset button to stop the Auto play.

■ NOTE LENGTH (CHORD LENGTH) EDITING

The note (chord) length of memory input to SOLO 1, SOLO 2, and CHORD 1 can be edited using one-key play.

<CHORD LENGTH>

- Set the function selector to 'record'.
 - Set the mode selector to 'chord'.
 - Press the 'auto play' button to produce the stored melodies.
 - Play a chord using the One Key Play buttons.
 - Press the 'reset' button.
- * Each press of the One Key Play buttons will play a stored chord.

<NOTE LENGTH>

- Set the function selector to 'record'.
 - Set the mode selector to 'Solo 1' or 'Solo 2'.
 - Press the 'auto play' button to produce the stored chord and melody.
 - Play the melody using the One Key Play buttons.
 - Press the 'reset' button.
- * Each press of the One Key Play buttons will play a stored note.

<One Key Play>

- One Key Play of 'solo 1'**
 - Set the function selector to 'play'.
 - Set the mode selector to 'solo 1'.
 - Tap the One Key Play buttons.

* It does not matter which of the two One Key Play buttons is pressed, or whether they are pressed in turn.
- One Key Play of 'solo 2'**
 - Set the function selector to 'play'.
 - Set the mode selector to 'solo 2'.
 - Tap the One Key Play buttons.

* It does not matter which of the two One Key Play buttons is pressed, or whether they are pressed in turn.

③ One Key Play of 'chord'

- Set the function selector to 'play'.
 - Set the mode selector to 'chord'.
 - Tap the One Key Play buttons.
- * It does not matter which of the two One Key Play buttons is pressed, or whether they are pressed in turn.

*SETTING ONE KEY PLAY (AUTO PLAY) TONES

When the mode selector is in the solo 1 position, the tone assigned to the tone selector pressed will only be applied for solo 1. Set the mode selector to the solo 2 position to change the solo 2 tone.

* Both solo 1 and solo 2 are assigned the same tone when the mode selector is set to normal.

NOTES

- One Key Play plays back the melody in solo 1 when the mode selector is set to normal.
- The memory contains the 'Toy Symphony' after the demo button is used to play the demonstration tune.

5. Correcting a wrong note/chord

<Immediate>

Press the Delete button and play the correct note/chord.

* The Delete button cannot be used during input while playing back using Auto play. Corrections can be made after input is complete.

<After storing>

Set the function selector to 'record' and the mode selector to 'solo 1', 'solo 2' or 'chord'. Use the One Key Play buttons to take the melody up to the note/chord to be corrected. Make corrections as follows.

- Deleting an unnecessary note/chord; Press the Delete button.
- Replacing the correct note/chord; Play the correct note/chord after pressing the Delete button.
- Adding an extra note/chord; Use the One Key Play buttons to move to the sound immediately before the point where the note/chord is to be inserted, and then play the note/chord.

* Changing the first chord in a piece after initial input is complete can cause memory contents to be altered. In such a case, either reinput all chords or correct the portions of the piece which have been altered.

| Symptoms | Possible cause | Remedy |
|--|---|--|
| No sound even when keys are pressed. | Volume control at minimum. | Reset volume control. |
| Occasional interference. | Refrigerator, washing machine or other electrical appliance. | Use outlet as far away as possible from appliance thought to be cause. |
| No sound when connected to external amplifier. | 1. Keyboard volume set at minimum. 2. Defective connection cord. | 1. Adjust keyboard volume control. 2. Connect correctly. |

① Avoid heat, humidity or direct sunlight.

Do not overexpose the unit to direct sunlight, place it near a heater, or in any area subject to high temperature.

② Avoid severe impacts and do not drop.

Severe impacts can result in malfunction. When carrying or transporting the unit, protect the keyboard and switches by packing with soft cloth.

③ Keep the unit free of liquids, dust, particles, etc.

Do not allow foreign matter to enter between the keys. Be especially careful of metallic objects such as hairpins, sewing needles or coins. Also, do not allow the unit to get wet.

④ Never attempt to modify any part of the unit.

Your keyboard is a precision musical instrument made up of sophisticated electronic parts. Any modification of, or tampering with internal components can cause trouble or malfunction.

*Note that the manufacturer assume no responsibility for any claims of loss, or malfunction made by third parties.

⑤ Do not use lacquer thinner or similar chemicals for cleaning.

Clean the keyboard with a soft cloth dampened with a mild neutral detergent solution. Soak the cloth in the solution and squeeze until almost dry.

⑥ In case of malfunction.....

When the unit does not work properly, check whether switches, connections, etc. are set correctly as indicated in the troubleshooting chart on page 25 of this manual. If the unit still does not work properly, contact the original retailer or a nearby dealer. Never attempt to repair the unit yourself. This can result in serious damage of the components.

| | |
|-------------------------------------|--|
| Model: | SK-1 |
| Keyboard: | 32 keys |
| Chords: | 4 notes maximum (4-note polyphonic) |
| Preset tones: | 5 PCM tones: piano, brass ensemble, trumpet, synth drums, human voice |
| Effects: | 3 Harmonic synthesis tones: flute, pipe organ, jazz organ |
| Envelope selection: | Vibrato, portamento |
| Envelope selection: | 13 |
| Synthesizer function: | Harmonic synthesis (16', 8', 5 1/3', 4', 2 2/3', 2', 1 3/5', 1 1/3', 1' up to 14 levels for each harmonic) |
| Auto-rhythms: | 11 rhythms: disco, rock, pops, march, samba, bossa nova, rumba, 4-beat, swing, slow rock, waltz <ul style="list-style-type: none"> • Fill-in key • Tempo keys |
| Auto accompaniment function: | Casio chord: maj, min, 7th, min7 Chord selector system: maj, min, 7th, min7, maj7, m7, dim, sus4, aug, 6th, min6, m7-5 <ul style="list-style-type: none"> • Playback tones: 2 |
| Memory play | 4-note polyphonic memory: Approximately 400 steps 3-channel multi memory: Chords: approximately 99 steps, solo 1/solo 2: 198 steps each <ul style="list-style-type: none"> • Auto play • One Key Play |
| Sampling function: | Method: 8-bit PCM Rate: 9.38kHz Time: Approximately 1.4 seconds (auto trigger system) Input method: Internal microphone, external microphone, line <ul style="list-style-type: none"> • Loop set • Envelope select |
| Demonstration function: | Toy Symphony (one-touch endless) |
| Terminals: | MIC; Input impedance 10KΩ Input sensitivity 4mv (VMS) LINE IN; Input impedance 100KΩ Input sensitivity 100mv (VMS) Output (mini); Output impedance 68Ω Output voltage 1.6V (VMS) |
| Tuning control: | ±30 cents |

| | |
|---------------------------|--|
| Speaker: | 8.0cm (output: 1W) |
| Power supply: | 3-way: Five AA-size batteries, household current (optional AD-1 AC adaptor), car battery (optional CA-1 car adaptor) Auto power off: Approximately 7 minutes after last operation |
| Power consumption: | 1.8W |
| Dimensions: | 461(W) × 155(D) × 44(H)mm 18 1/8"(W) × 6 1/8"(D) × 1 3/4"(H) |
| Weight: | Approx. 1.2kg (including batteries) 2.65lb |
| Accessories: | Five AA-size batteries |

*Design and specifications are subject to change without notice.

GUIDELINES LAID DOWN BY FCC RULES FOR USE OF THE UNIT IN THE U.S.A. (not applicable to other areas).

This equipment generates and uses radio frequency energy and if not installed and used properly, that is, in strict accordance with the manufacturer's instructions, may cause interference to radio and television reception. It has been type tested and found to comply with the limits for a Class B computing device in accordance with the specifications in Subpart J of Part 15 of FCC Rules, which are designed to provide reasonable protection against such interference in a residential installation. However, there is no guarantee that interference will not occur in a particular installation. If this equipment does cause interference to radio or television reception, which can be determined by turning the equipment off and on, the user is encouraged to try to correct the interference by one or more of the following measures:

- reorient the receiving antenna
- relocate the computer with respect to the receiver
- move the computer away from the receiver
- plug the computer into a different outlet so that computer and receiver are on different branch circuits.

If necessary, the user should consult the dealer or an experienced radio/television technician for additional suggestions. The user may find the following booklet prepared by the Federal Communications Commission helpful: "How to Identify and Resolve Radio-TV Interference Problems". This booklet is available from the US Government Printing Office, Washington, DC., 20402, Stock No. 004-000-00345-4.