

 **BOSS**

DR-55

Dr. Rhythm
OWNER'S MANUAL



BATTERY POWER

FEATURES DR-55

Dr. Rhythm is an extremely small and compact programmable rhythm machine. Sixteen different rhythm patterns can be loaded into the memory, and will be remained even when the power switch is turned off. Each rhythm pattern is divided into sixteen steps with each step loaded one at a time for quick and accurate loading. The three rhythm sounds are: bass drum, snare drum, and rim shot. A standard pattern hi hat sound can also be added to each rhythm. Accents can also be programmed into each pattern. Other machines such as a sequencer or synthesizer can be used with Dr. Rhythm.

CONNECTIONS

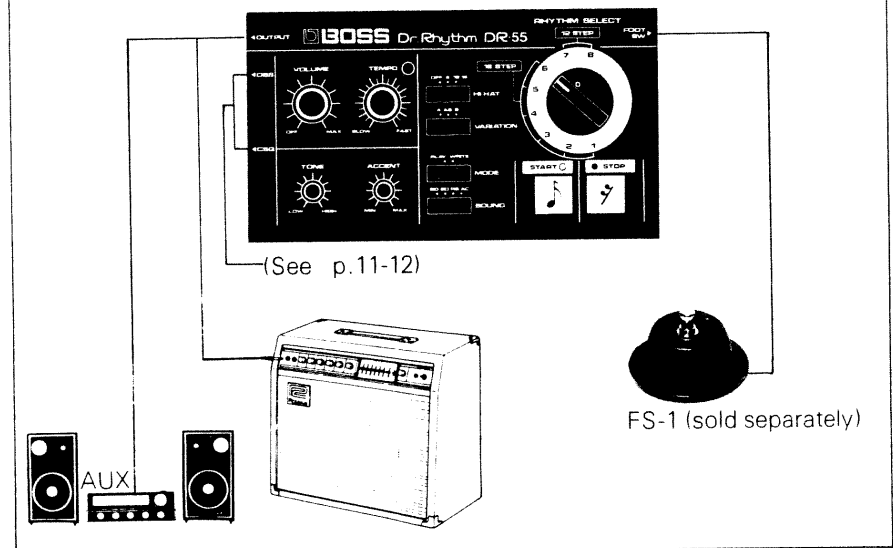

2

OPERATION **PLAY** Mode.

Standard rhythm patterns were loaded into memory at the time of manufacture so that Dr. Rhythm is ready to use right out of the box.

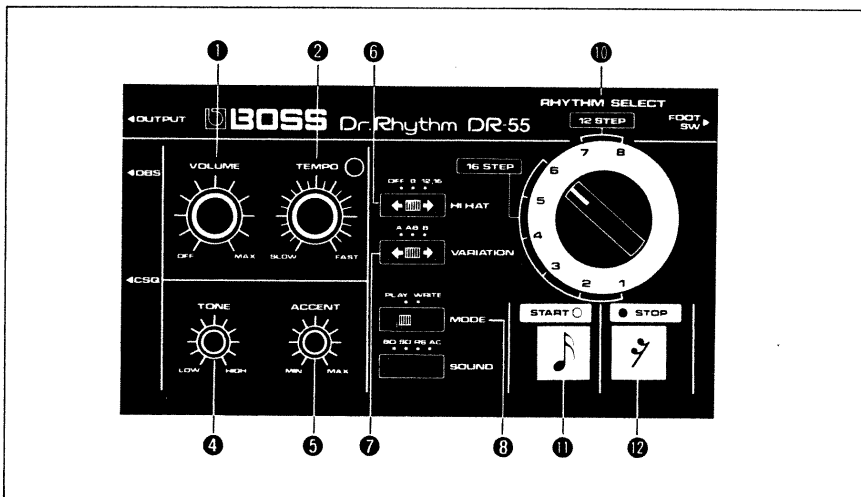

1. Set the controls as shown in the drawing.

2. Press START **9** to start the rhythm and STOP **10** to stop it.

3. Adjust the loudness of the sound with the VOLUME control **1** and the external amplifier volume control.

4. While listening to the rhythm, try the TEMPO **2**, TONE **4**, ACCENT **5**, HI HAT **6**, VARIATION **7**, and RHYTHM SELECT **3** controls to see what effect they have. These controls are covered in detail in the following pages.





NOTE: Do not change the position of the MODE switch **8**.

3

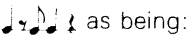
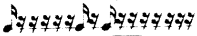
WRITE Mode

Writing a rhythm into memory will erase any previous rhythm pattern written there, so be sure that the RHYTHM SELECT ⑩ and VARIATION ⑦ switches are set as desired before writing new patterns.

With Dr. Rhythm, each measure is divided into sixteen steps (or twelve steps). Rhythm patterns are written into memory separately for each sound, one step at a time for one (or two) measures. For the purposes of writing rhythm patterns, the patterns should be thought of in terms of sixteenth notes. In other words, think of  as being: 

To load this pattern, press  ① for  and  for .

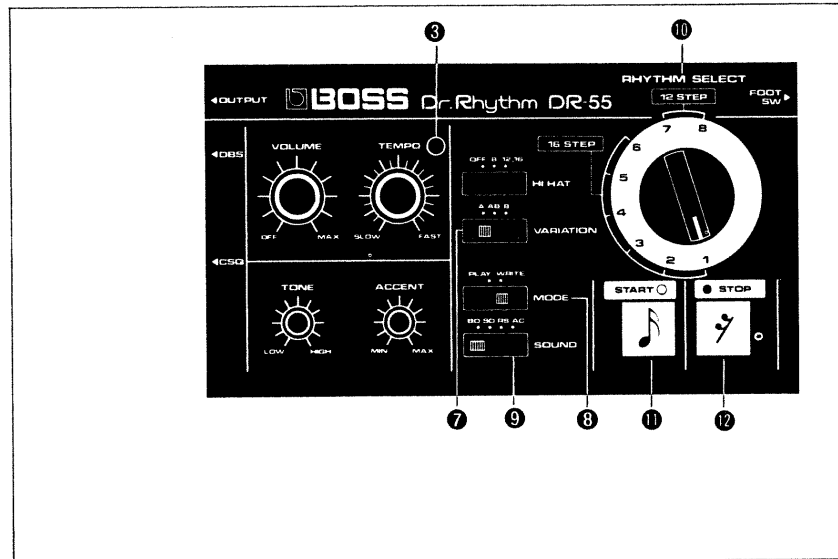

4

Writing 16-Step Patterns

1 Set RHYTHM SELECT ⑩ as desired; set the VARIATION switch ⑦ at "A" or "B".

In the example, the rhythm pattern will be loaded as rhythm pattern 1-A.

2 Set the MODE switch ⑧ at WRITE; the TEMPO indicator ③ should light indicating the beginning of the measure.

NOTE: The MODE switch ⑧ should be changed to the WRITE position *only* when the rhythm pattern is not running.

If the TEMPO indicator ③ does not light, use either of these two methods:

Press  ⑫ enough times to light the TEMPO indicator.



Set the MODE switch ⑧ at PLAY

and press «STOP», then return the MODE switch ⑧ to WRITE.

3 Select the desired sound with the SOUND switch ⑨.

BD=bass drum; SD=snare drum; RS=rim shot; AC=accent

In the example, the bass drum sound has been selected for loading.



4 Write the rhythm using the  ① and  ⑫ buttons. After loading sixteen steps, the TEMPO indicator ③ will light showing that the measure is fully loaded.

If the TEMPO indicator ③ does not light, it indicates that the measure has not been completely loaded. Check by playing the rhythm, or write the rhythm again from the beginning.

5 Repeat Steps 3 and 4 above for

the other two sounds.

In the rhythm shown, the rim shot sound is not used. Set the SOUND switch ⑨ at "RS" and press  ⑫ sixteen times to clear the memory. If this is not done, the previously loaded rim shot pattern will be produced when the rhythm is played.

6 To add accents to the rhythm pattern, set the SOUND switch ⑨ at "AC" and press  ① at those points where an accent is desired and  ⑫ where accents are not desired. If no accents are desired at all for the pattern, press  ⑫ sixteen times to clear the memory of the previously loaded accents.

7 To check the pattern, set the MODE switch ⑧ at PLAY and press the START ⑪ button.

5

Writing 12-Step Patterns

Set RHYTHM SELECT ⑩ at either "7" or "8". Load in the same manner as above, but using twelve steps instead of sixteen.

12-step rhythm patterns can be used for triple rhythms such as 3/4 and 3/2.

Writing 32- and 24-Step Patterns

If the VARIATION switch ⑦ is at "AB", the rhythm pattern will alternate between A and B when played. Often, the pattern loaded into B is a variation of the A pattern in order to get more variety during performance; however, if the two 16-step (or 12-step) measures produced by the AB pattern are thought of as one 32-step (or 24-step) measure, patterns based on 32 and 24 steps can be programmed.

6

HI HAT

SD

BD

BD

SD

RS

ACC

(Writing is finished)

OFF 8 12, 16

HI HAT

PLAY WRITE

MODE

START

VOLUME

ACCENT

TONE

TEMPO

To load, set the VARIATION switch ⑦ at "AB" and load 32 steps (or 24 steps with RHYTHM SELECT ⑩ at "7" or "8"). The TEMPO indicator ③ will light once halfway through the pattern, and again at the end of the pattern to indicate that loading is complete.

Example of use:

With a little forethought, it would be possible to load various rhythm patterns such as an introduction, fill-ins, breaks, etc. into the various memory slots in such a way that the rhythm part for an entire composition could be produced non-stop by changing the RHYTHM SELECT ⑩ and VARIATION ⑦ switches while the rhythm pattern runs. To accomplish this, rhythm patterns at the beginning of the composition should be loaded into the lower numbered

places of the RHYTHM SELECT switch ⑩. For example, the introduction should be loaded into position 1. The main rhythm patterns for the composition should be near the center; positions 3 and 4, for example. Position 6 would be used for the close. In this way, the RHYTHM SELECT ⑩ switch need be moved only one step at a time when a change occurs. Changes in RHYTHM SELECT ⑩ and the VARIATION switch ⑦ should be made as close to the bar lines as possible in order to produce a smooth transition.

7

NAMES AND FUNCTIONS OF THE CONTROLS

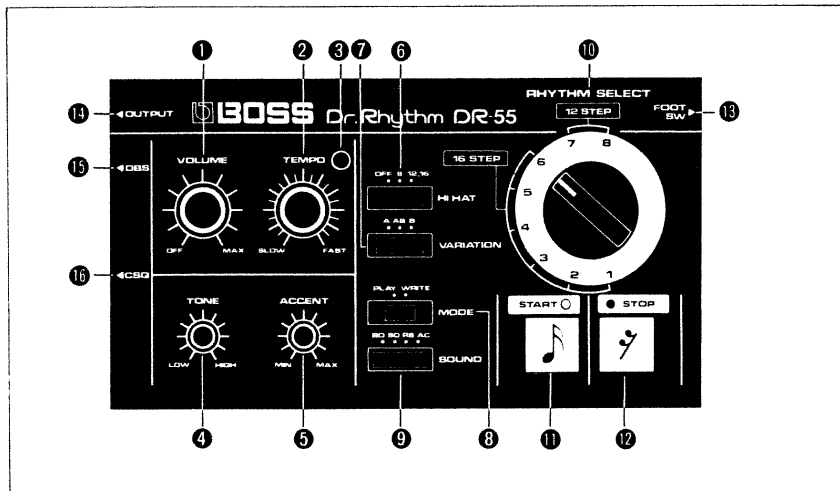

8

it comes on again to indicate that loading is complete.

④ TONE Control

Controls the tone color of the percussion sounds.

⑤ ACCENT Control

Controls the dynamic range of the rhythm patterns. At MIN, the programmed accents will be weak; at MAX, strong.

If accents are not programmed, this control has no effect on the sound.

⑥ HI HAT Switch

This switch is for adding the hi hat sound to the programmed pattern. At OFF, there is no hi hat sound. At "8", the hi hat sound will occur eight times per measure. At "12/16", the hi hat will occur twelve times per measure in the 12-beat rhythm and sixteen times for the 16-beat rhythm.

⑦ VARIATION Switch

For each position of RHYTHM SELECT ⑩ it is possible to load two rhythm patterns: A and B. In other words, using the A and B variations and the eight positions of RHYTHM SELECT ⑩, it is possible to load sixteen separate rhythm patterns.

In the PLAY mode:

At "A" or "B", the A and B variations are produced. At "AB", the A and B patterns are played one after the other in series: A, B, A, B, etc.

In the WRITE mode:

The VARIATION switch ⑦ determines which variation memory (A or B) the pattern will enter when loaded. At "AB", two measures can be loaded in series.

① VOLUME Control/POWER Switch

The VOLUME control ① also serves as the POWER switch. Turn the VOLUME control ① fully counter-clockwise to turn the DR-55 off.

NOTE: The POWER switch function is interlocked to the OUTPUT jack ⑭. If there is no connection at the OUTPUT jack ⑭, the DR-55 cannot be turned on.

② TEMPO Control

Controls the tempo of the rhythm when played.

③ TEMPO Indicator LED

Flashes at the beginning of each measure.

In the PLAY mode, the TEMPO indicator ③ gives a visual indication of the tempo.

In the WRITE mode, the TEMPO indicator ③ indicates the point where loading can begin, and after loading the correct number of steps (12 or 16),

⑧ MODE Switch

Determines whether the DR-55 is in the PLAY mode or WRITE mode. When not actually programming rhythm patterns, this switch should always be left in the PLAY mode position to prevent accidental erasure of rhythm patterns.

⑨ SOUND Switch

Used to select sounds and accent when programming rhythm patterns.

BD = bass drum; SD = snare drum; RS = rim shot; AC = accent

⑩ RHYTHM SELECT



In PLAY mode, determines which rhythm will be played; in WRITE mode, determines where the rhythm will be written.

9

11 START  **Button**

12 STOP  **Button**

In the PLAY mode, these buttons control the start and stop of the rhythm patterns. Pressing START will always start the rhythm from the beginning of the measure. When the rhythm is not running, the STOP button **12** can be used to return the rhythm sequence to the first beat in the measure.

In the WRITE mode, these buttons are used to load the sound selected with the SOUND switch **9**. The rhythm is loaded one step at a time; press  **11** for those steps where the sound is to occur and press  **12** where no sound is to occur.

13 FOOT SWITCH Jack

By connecting a foot switch (such as the Roland FS-1; sold separately) to the FOOT SWITCH jack **13**, it is possible to control the START/STOP

function of the DR-55 remotely when in the PLAY mode.

14 OUTPUT Jack

For connection to an amplifier. A cord must be connected to this jack to be able to turn on the POWER SWITCH **1**.

15 DBS Jack

16 CSQ Jack

For controlling external devices with the DR-55.

DBS: Outputs a pulse for each step in the rhythm pattern.

CSQ: Outputs a pulse at each step where an accent is programmed. When this jack is used, accents no longer occur in the programmed rhythm patterns.

With new batteries, the output pulses are:

DBS: +5v, 8ms

CSQ: +4v, 10ms

Remember that these pulse levels will

become lower as the batteries age.

10

USING EXTERNAL DEVICES

1. Using the CSQ-100 Digital Sequencer

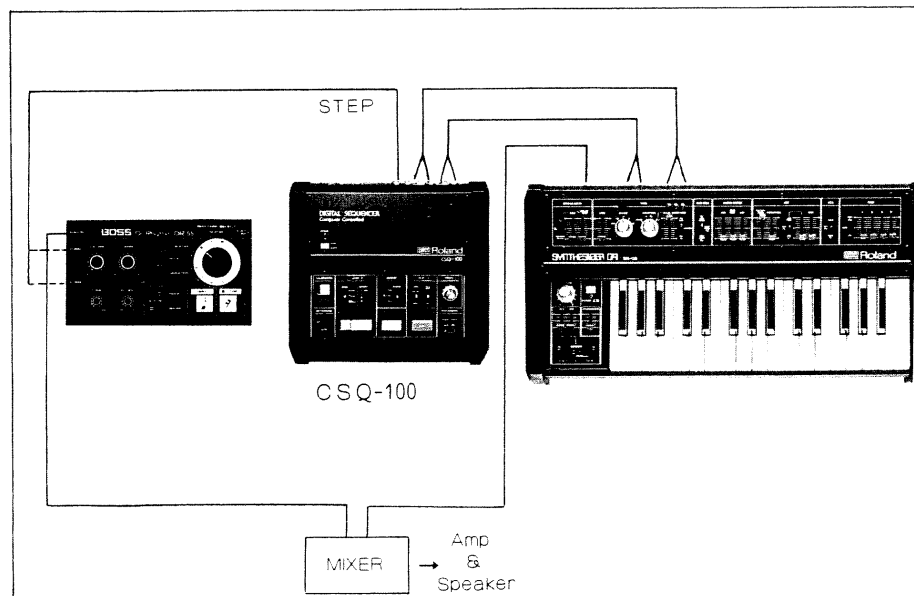

11

A. DBS jack ⑬ to the CSQ-100 STEP INPUT jack

The CSQ-100 will advance one step each time the DR-55 advances one step. (one step = sixteenth note).

B. CSQ jack ⑭ connected to CSQ-100 STEP INPUT jack

The CSQ-100 will advance one step at each point where an accent is programmed.

If the position of RHYTHM SELECT ⑩ is changed at the end of each measure, twelve measures of different melody rhythm can be played.

If the CSQ jack ⑭ is connected to the CSQ-100 GATE INPUT jack, the CSQ-100 GATE REWRITE mode can be used for programming rhythm patterns loaded into the DR-55.

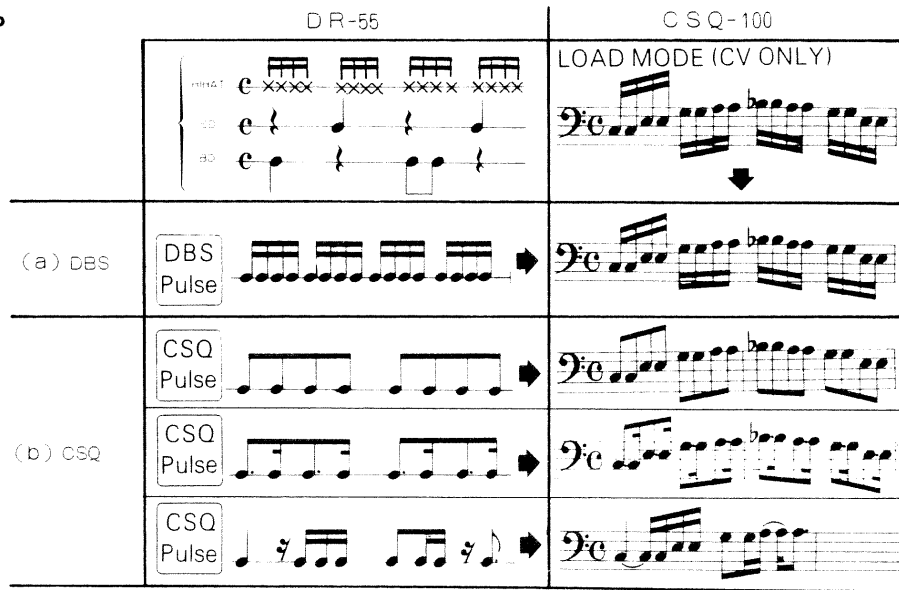

12

2. Using the JP-4 Polyphonic Synthesizer

The DBS output ⑬ can be used to control the JP-4 arpeggio rate.

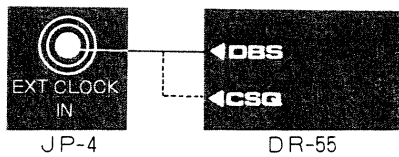

3. Using the System 100M Synthesizer

A percussion voice can be synthesized with the System 100M Synthesizer and triggered from the CSQ jack ⑭. In this way, another voice can be added to the DR-55 rhythm patterns.

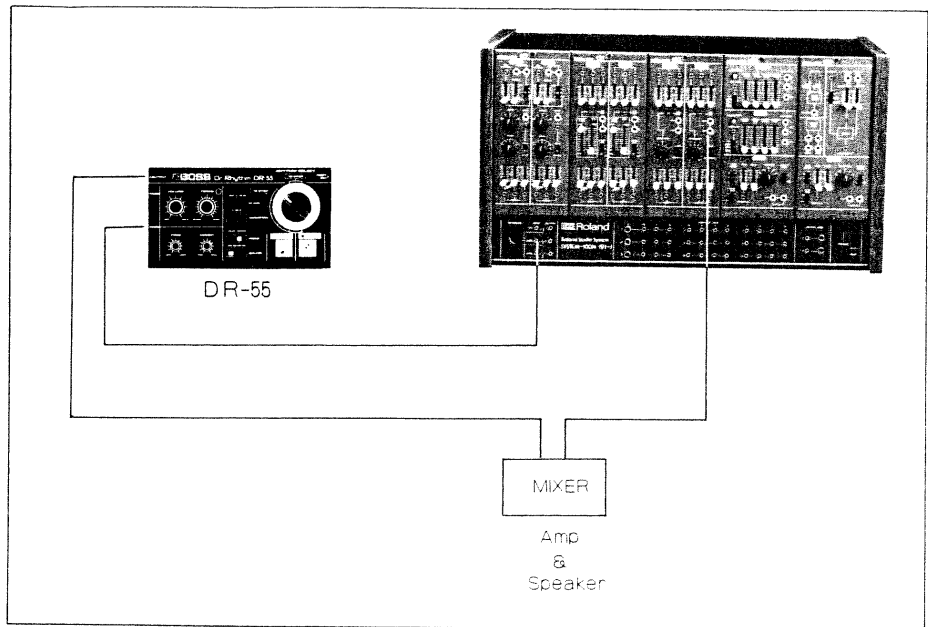

13

Examples: Use the CSQ-100 Digital Sequencer for percussion voices with pitch or tone color changes.

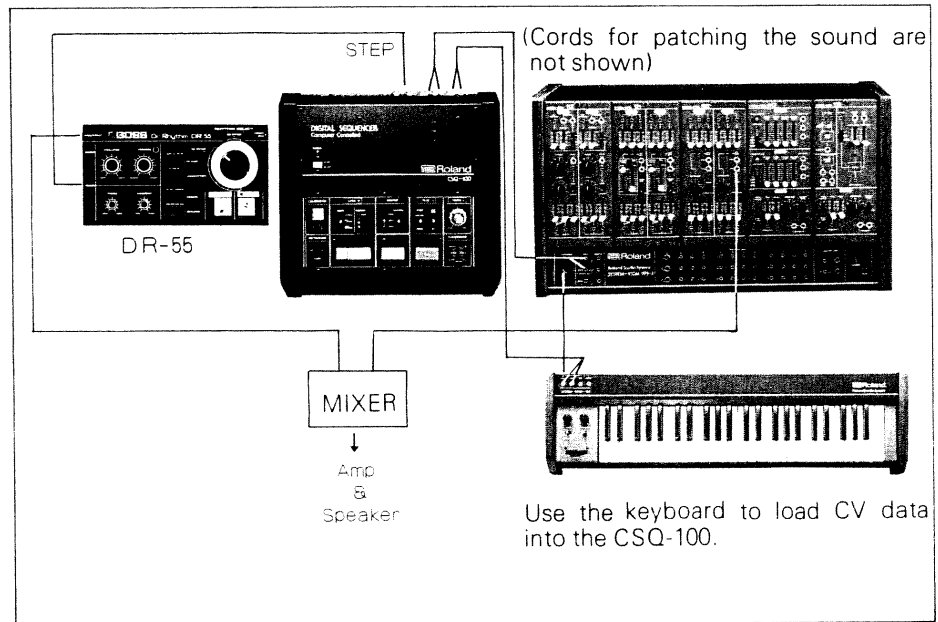

14

CHANGING BATTERIES

When the batteries have become one year old, or when the tone color of the percussion sounds begins to deteriorate, the batteries should be replaced. If the new batteries are inserted within approximately three minutes of removing the old batteries, the rhythm patterns contained in the memory will remain intact.

TO REPLACE:



1. Turn off the POWER switch **⏻**; remove the screw and open the lid.
2. Being careful of the wires, remove the battery case from the compartment and un-snap the connector from the battery case.
3. Replace the old batteries with new batteries; **OBSERVE POLARITY.**
4. Re-connect the connector.
5. Being careful not to pinch the wires, replace the battery case in its compartment.
6. Close the lid and replace the screw.

15

SPECIFICATIONS

DR. RHYTHM DR-55

Controls and Switches

- VOLUME Control/POWER Switch ①
- TEMPO control ② (TEMPO Indicator ③)
- TONE Control ④
- ACCENT Control ⑤
- HI HAT Switch (OFF, 8, 12/16) ⑥
- VARIATION Switch (A, AB, B) ⑦
- MODE Switch (PLAY, WRITE) ⑧
- SOUND Switch (BD, SD, RS, AC) ⑨
- RHYTHM SELECT (1-8) ⑩
- START  Button ⑪
- STOP  Button ⑫

Jacks

- OUTPUT Jack ⑬
- DBS Jack ⑭ (output pulse: + 5V, 8ms)
- CSQ Jack ⑮ (output pulse: + 4V, 10ms)
- FOOT SWITCH Jack ⑯ (for FS-1)

Power Supply: 6V dc

Dimensions: 211(w) x 116(d) x 53(h) mm

Weight: 850g

Accessories: Batteries UM-3
Connection cord (PJ-1)

Specifications are subject to change without notice

16

Standard rhythm patterns were loaded into memory at the time of manufacture.

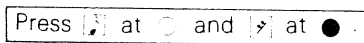

Adjust TEMPO control as desired.

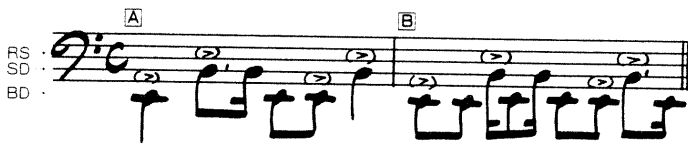

RHYTHM SELECT ②

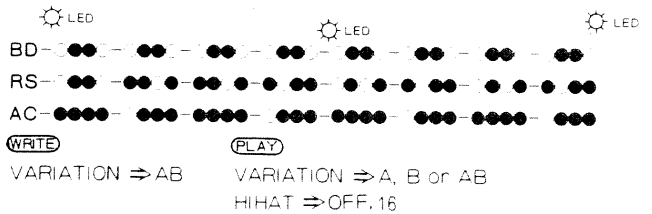
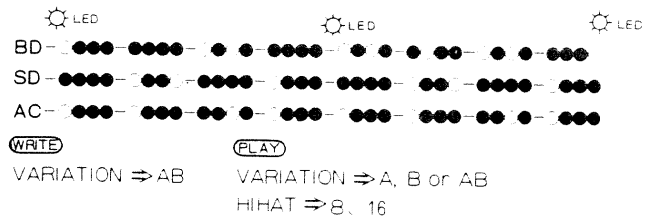

17

RHYTHM SELECT 3

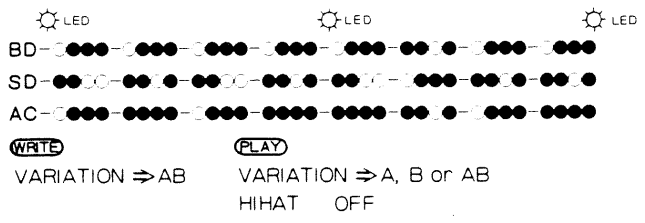

RHYTHM SELECT 4

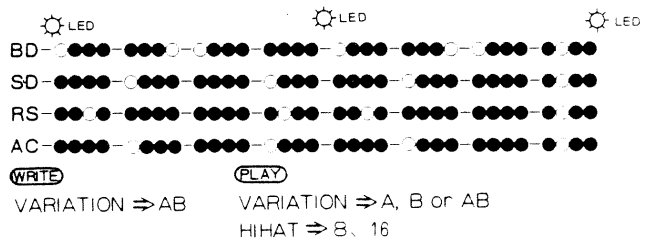

18

RHYTHM SELECT 5

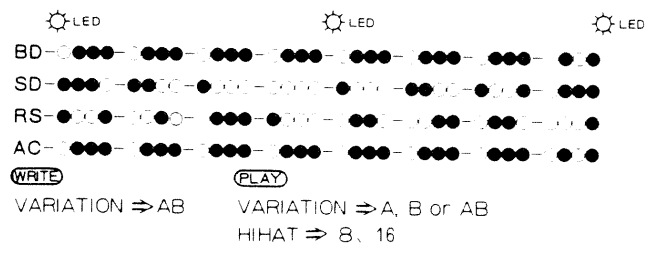
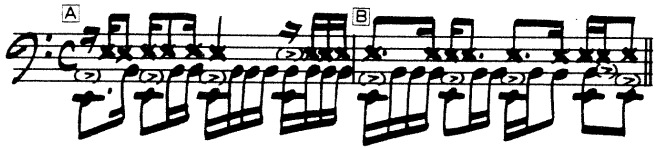

RHYTHM SELECT 6

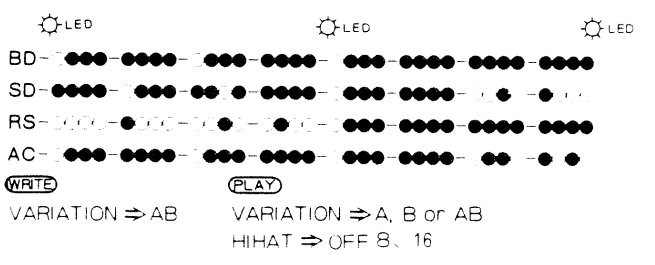
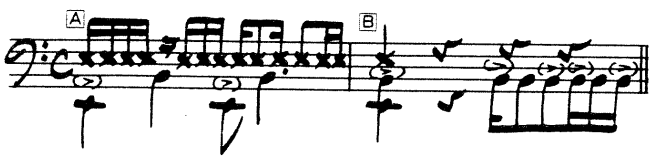

19

RHYTHM SELECT 7



RHYTHM SELECT 8

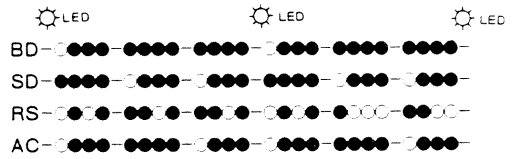

WRITE

VARIATION ⇒ AB

PLAY

VARIATION ⇒ A, B or AB

HIHAT ⇒ (6) 12

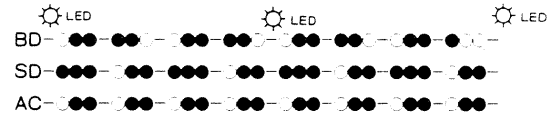

WRITE

VARIATION ⇒ AB

PLAY

VARIATION ⇒ A, B or AB

HIHAT ⇒ 8, 16

 **BOSS**
Products of Roland JAPAN

DR-55 OWNER'S MANUAL '82 JAN. E-3

 Roland®

10128

UPC 10128



10981

 BOSS